



Ningbo Jiangbei Woson Medical Instrument Co., Ltd

Technical Publications

TANDA Steam Sterilizer

Operation Manual

ASS0007
REV-E



Operation Documentation

Regulatory Requirement

This product complies with regulatory requirements of the following European Directive 93/42/EEC concerning medical devices.



Ningbo Jiangbei Woson Medical Instrument Co., Ltd

Address: No.25, Lane 300, Jinshan Road, Jiangbei District,
Ningbo 315032, China

Tel: 86-574-83022668

Fax: 86-574-87639376

Website: www.woson.com.cn

E-mail: overseas@woson.com.cn

Revision History

REV	ISSUE DATE	REASON FOR CHANGE
Rev-A	2009.02.01	First Issue
Rev-B	2009.09.08	Version Change
Rev-C	2010.04.26	Version Change
Rev-D	2012.07.29	Version Change
Rev-E	2016.06.25	Version Change

Please verify that you are using the latest revision of this document. Information pertaining to this document is maintained on manufactory. If you need to know the latest revision, please contact your distributor, sales representative, or our service dept.

Regulatory Requirements

Conformance Standards

The content of this instruction is fit for sterilizers.

Above sterilizer accord with the requirements of European Class B:

93/42/EEC

97/23/EC

EN 61010-1

EN 61010-2-040

EN 13060

EN 61326-1

European Authorized Representative

DTF Technology s.r.l.

Address: via Gressoney 9, 20137 Milano

Tel: 39 02 84893641

Fax: 39 02 84718594

This product complies with the regulatory requirement of the following:

- Council Directive 93/42/EEC concerning medical devices:

The CE label affixed to the product testifies compliance to the Directive.

The location of the CE marking is shown in this manual.

Certifications

Manufactory is EN ISO 9001 and EN ISO 13485 certified.

Original Documentation

The original document was written in English.

Declaration of Conformity

Council Directive 93/42/EEC concerning medical devices:

The CE label affixed to the product testifies compliance to the Directive.

The location of the CE marking is shown in this manual. In this manual there are present the CE certification and the Conformity. Check appendixes.

Table of Content

Regulatory Requirements	1
Revision History	2
Regulatory Requirements	3
Chapter 1 Introduction	6
Chapter 2 Safety	7
2.1 Sign Explanation.....	7
2.2 General Safety Recommendations	8
2.3 Safety Parts	9
2.4 Operation Risk.....	10
2.5 Protection Device	10
Chapter 3 Receiving and Installation	11
3.1 Check the Package	11
3.2 Unpack the Accessories	11
3.3 Optional Accessories	12
3.4 Installation Environment	12
3.5 Installation.....	13
3.6 Power Connection	13
Chapter 4 Description and Specification	14
4.1 Front View.....	14
4.2 Rear View	15
4.3 Open View	15
4.4 External Size	16
4.5 Loading Size.....	16
4.6 Specification	16
4.7 Sterilization Cycle	18
Chapter 5 Panel and Functions	19
5.1 Display Panel.....	19
5.2 Controlling Button	19
5.3 Sterilization Program	21
5.4 Window of Sterilization Cycle	21

Chapter 6 Operation Process	23
6.1 Switching On	23
6.2 Distilled Water Adding	23
6.3 Alarming if Used Water Reservoir is Full.....	24
6.4 Selecting Sterilizing Program	24
6.5 Loading Articles	24
6.6 Closing the Door.....	25
6.7 Starting a Program.....	26
6.8 End of the Sterilization Working Cycle	28
6.9 Power Off.....	28
6.10 Abnormal Exiting.....	29
Chapter 7 Essential Information	32
Chapter 8 Maintenance	32
8.1 Maintenance Schedule Chart.....	32
8.2 Daily Maintenance	32
8.3 Weekly Maintenance	33
8.4 Monthly Maintenance	34
8.5 Other Maintenance	35
8.6 Servicing by the Approved Technician	36
Chapter 9 Transportation and Storage	37
Appendix 1 Instruments Preparation Procedure	38
Appendix 2 Error Code List	39
Appendix 3 Piping and Circuit Diagram	40
Piping Diagram	40
Circuit Diagram	41
Appendix 4 The Standards of Testing	42

Chapter 1 Introduction

1.1 Attention

- ❖ This operation manual contains necessary and sufficient information to operate the sterilizer safely, like optimal usage, safe and reliable operation, regular and correct servicing requirements.
- ❖ Read and understand all instructions in this manual before attempting to use the product.
- ❖ Keep this manual with the sterilizer at all times. Periodically review the procedures for operation and safety precautions.

1.2 Usage Indications

Application to all wrapped or non-wrapped, solid, hollow load products type A and porous products or related articles.

This sterilizer can be used for dental clinic, laboratory, surgical room, emergency room, ophthalmology, gynecology and steam, cosmetic hospital and so on, by doctors and professionals.





1.3 Contraindication

There is no any contraindication of this equipment.







Chapter 2 Safety

2.1 Sign Explanation

Device Sign Description

	<p>“ATTENTION” – Refer to this Operation Manual” is intended to alert the user to refer to the operation manual or other instructions when complete information cannot be provided on the label.</p>
	<p>“ATTENTION” – Pay attention to the high temperatures in the chamber, and to the sterilizer exterior when exhausting system is running.</p>
	<p>“Protective Earth” - Indicates the protective earth (grounding) terminal.</p>
	<p>“CAUTION” - Dangerous voltage” (the lightning flash with arrowhead) is used to indicate electric shock hazards.</p>

Label Description

	<p>Symbol for "SERIAL NUMBER"</p>		<p>Symbol for "MANUFACTURER"</p>
	<p>Symbol for "CATALOGUE NUMBER"</p>		<p>Symbol for "AUTHORISED REPRESENTATIVE IN THE EUROPEAN COMMUNITY"</p>
	<p>Symbol for "DATE OF MANUFACTURE"</p>		<p>Symbol for "CAUTION"</p>

Operation Prompt

Note	Indicates that concerned information is easier or helpful in operation
Caution	Indicates that a potential hazard may exist which, through inappropriate conditions or operation, will or can cause: <ul style="list-style-type: none"> • Minor injury • Property damage. • Damage to machine
Warning	Indicates that a specific hazard exists which, through inappropriate conditions or operation, may cause: <ul style="list-style-type: none"> • Severe personal injury • Substantial property damage • Substantial damage to machine

NOTE: Indicates precautions or recommendations that should be used in the operation.

2.2 General Safety Recommendations

- ❖ The user is responsible for proper operation and maintenance of the sterilizer in accordance with the instructions listed in this manual.
- ❖ The sterilizer could not be used for liquid.
- ❖ The sterilizer could not be used for gas.
- ❖ The trays and the load will still be hot at the end of each cycle. Use the tray holder to remove each tray from the chamber.
- ❖ Do not open the door of the chamber during the sterilization programs.
- ❖ Do not put you hands or face on the cover of the water tank when the sterilizer is running.
- ❖ Do not remove the instruction plate or any label from the sterilizer.
- ❖ Do not pour water or any other liquid over the sterilizer.
- ❖ Do not fill the caustic liquid into the water tank.
- ❖ Do not fill the caustic matter in the chamber.
- ❖ Use only high quality distilled water.
- ❖ Unplug the mains lead before inspecting or servicing the machine.

- ❖ Only an approved technician using original spare parts can carry out repairs and maintenance.
- ❖ In case of transportation, drain both water tanks completely, allow the sterilization chamber to cool down and preferably use the original packaging.
- ❖ The articles under sterilization should be removed by special tools when the temperature over 40°C.
- ❖ Picking-up the sterilizing trays should use the special tools provided.
- ❖ During the transportation, the sterilizer should be carried by two people in case of turning over.
- ❖ Notice! This product can't be put on the place that is not easy to cut off power supply.
- ❖ Prohibit covering the lid of water tank during usage.

2.3 Safety Parts

Temperature Protection

Part Name	Function
Temperature Protector (Steam Generator)	Cut off current when the steam generator temperature is too high.
Temperature Protector (Heating Ring)	Cut off current when the heating ring temperature is too high.

Electricity Protection

Part Name	Function
Double Fuse	Cut off current when the connected power is too high or unstable.
Electronic Filter	Filter the electromagnetic interference during working.

Mechanical Protection

Part Name	Function
Jiggle Switch	Ensure the door closed completely, avoiding safety risk.
Tray Tong	Avoid scald when removing articles from the chamber

Control Part

Part Name	Function
Temperature Sensor (Internal)	Measure temperature inside the chamber
Temperature Sensor (Heating Ring)	Measure temperature of the heating ring
Temperature Sensor (Steam Generator)	To measure temperature of the steam generator
Pressure Sensor	To measure pressure of the chamber
PCB Control	Control system for all the process of sterilization

CAUTION: Manufacturer is not held responsible for any arbitrary disassembly, amendment with the unit, by unauthorized person or unprofessional technician.

2.4 Operation Risk

Please take attention on avoid operation risk during operation.

Scald risk

- ❖ Every time opening the door after sterilization cycle, please keep an appropriate distance, because the chamber still has rudimental steam with high temperature.
- ❖ Every time open the door after sterilization cycle, please not touch the main door and chamber, because of high temperature, and avoid to be scalded.

Pollution risk

Please clean the chamber after every time use to avoid rudimental contamination left inside chamber.

2.5 Protection Device

Device Name	Function
Plastic or fabric glove	Useful during load and remove articles, avoid scald.

Chapter 3 Receiving and Installation

3.1 Check the Package

Please check package carefully when you receive the product.

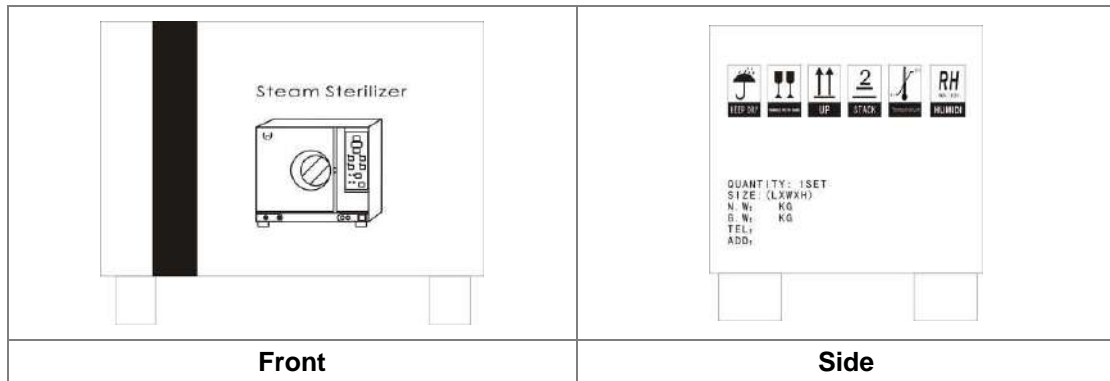

Item	TANDA 18	TANDA 23
	Packing Size (mm)	660x525x495
Gross Weight (Kg)	52	58

3.2 Unpack the Accessories

Open the package and take the product out, remove the plastic bag then open the door to take all the accessories and check as following:

No.	Part Name	Qty
1	Rack	1 piece
2	Tray	3 sets
3	Removal Tool	1 piece
4	Draining Tube	1 piece
5	Power Supply Cable	1 piece
6	Door Gasket	1 piece

3.3 Optional Accessories

Name	Model	QTY	Picture
USB Reader	1G	1	
Thermal Printer	PINTER20 (SP-POS58VTH)	1	

3.4 Installation Environment

The sterilizer should be set in a place which at least has 10cm distance against each side (20cm to the top) as following:

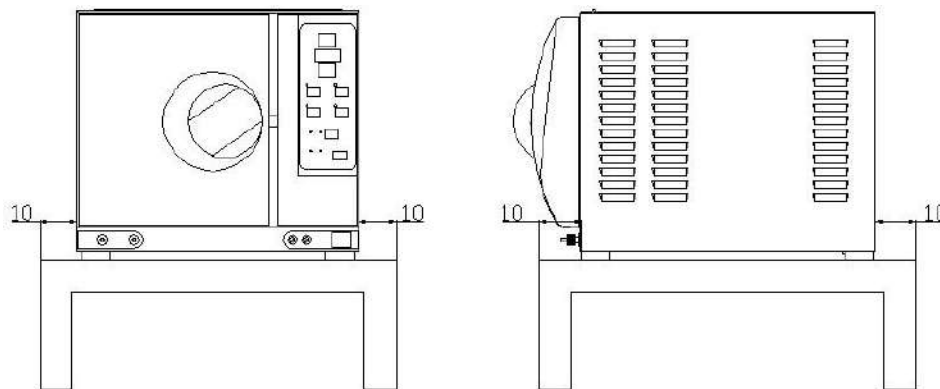

- ❖ The sterilizer should be set in a place with good ventilation.
- ❖ The temperature of environment: 5-40°C
- ❖ The humidity of environment: ≤85%
- ❖ Atmosphere pressure: 860Hpa~1060Hpa
- ❖ An earth connection is essential.

CAUTION: Do not place any stuff which easily melts near the sterilizer.

3.5 Installation

- ❖ The sterilizer should be set on level table or place; the front-end should be a little bit higher than back-end(via front pads).
- ❖ The sterilizer cooling and vent area should not be jammed or blocked.
- ❖ Do not put any stuff on the top of the sterilizer.
- ❖ Do not put any stuff in front of the door, to avoid accident when open the door.
- ❖ Do not put any corrosive stuff near the sterilizer to avoid accident or risk.

3.6 Power Connection

- ❖ The sterilizer should be connected with a stable and separated power source.
- ❖ Power socket is at the back of the sterilizer.
- ❖ Please confirm the connection power is complied with specification of nameplate at the back of sterilizer.

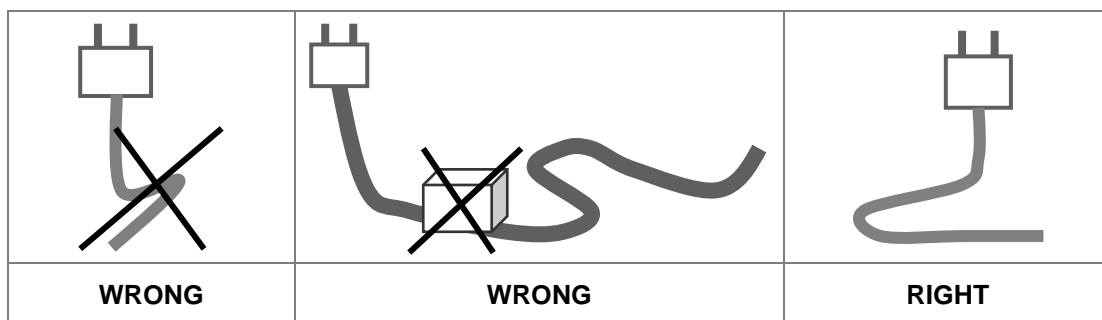

CAUTION: Do not bend the power wire to avoid damage of power wire.

Do not put any heavy stuff on the power wire to avoid damage of power wire.

Do not use other power wire to avoid damage of sterilizer.

Do not try to add the power wire to avoid accident and risk.

Chapter 4 Description and Specification

4.1 Front View



No.	Name	Description
1	Water Filling Port	Manually filling water
2	Drainage Port	Connected to used water tank
3	Drainage Port	Connected to main water tank
4	Fuse	Protect product when the power is not stable
5	Power Supply Switch	Standard green power switch
6	Displaying Window	Show temperature, pressure or other sterilization information on the window, easy to operate during the working
7	Door Handle	Door handle with safe door locker to open and close the door

4.2 Rear View



No.	Name	Description
8	Power socket	Connected with power source
9	Printer out port	Connect a mini printer and output sterilization record
10	Relief Valve	Leak pressure automatically when over working pressure
11	Nameplate	Basic information of manufacturer
12	Vent area	Output heat from this vent area by condenser

4.3 Open View

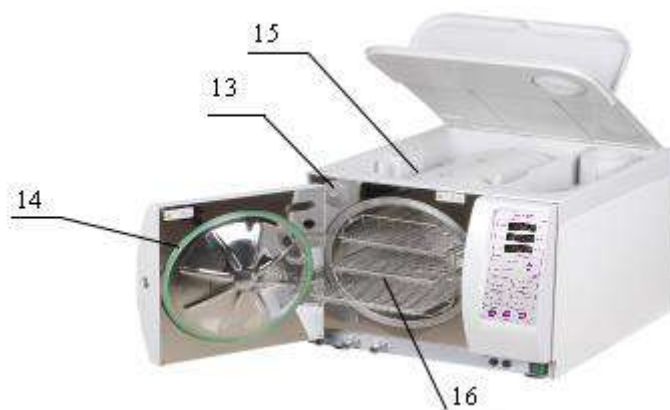

No.	Name	Description
13	Air Filter	Filter the air and ensure air into chamber is clean
14	Door Seal	For sealing the door
15	Water level sensor	For used water tank
16	Tray & Rack	To load the articles

4.4 External Size

Item	18L	23L
Size of Closed Door(AxBxC)	445x400x560	445x400x670
Size of Opened Door(AxBxD)	445x400x830	445x400x940

4.5 Loading Size

The loading size of sterilizer as followed:

18L	23L
285	385
204	204
198	198

4.6 Specification

Basic Specification

Rated voltage: a.c.220V-230V, 50Hz

Rated power: 18L/ 1500VA, 23L/ 1700VA

Fuse: T10A

Operation temperature: 5~40°C

The board affording weight: 4000 N/m²

Noise: < 50db

Maximum capacity of one tray: 1000g

The frequency of water draining: once a day, drain the water once you find “waster water over” during operation.

The maximum duration of using loading test: 90mins

The maximum thermal radiation energy under the condition of 20°C-26°C <2000J

Sterilizer Chamber

Material: stainless steel (for medical)

Max. work pressure: 2.5bar

Min. work pressure: -0.9bar

Max. temperature: 145°C

Chamber volume: 18L(Φ245×352mm) 23L(Φ245×450mm)

Loading size: 18L (198×204×285mm) 23L(198×204×385mm)

Max. loading weight: 18L (3.07kg/cm²) 23L (3.21kg/cm²)

Working pressure/temperature: 1.10~1.30bar/121°C~122°C; 2.10~2.30bar/134°C~135°C

Water volume for one cycle: 0.16L~ 0.18L

Sterilizer Steam Safety Valve

Safety release pressure: 2.45bar

Max. working temperature: 160°C

Water Tank

Main water tank volume: 18L (3.5L) 23L (4L)

CAUTION: Water added into main water tank must be distilled water!

Water temperature must be under 40°C

Test Method

- ❖ Vacuum Test
- ❖ B&D Test
- ❖ Helix Test

Chapter 5 Panel and Functions

5.1 Display Panel

5.1.1 Temperature display

Indicate real time in-chamber temperature.

Unit: °C

5.1.2 Pressure display

Indicate real time in-chamber pressure.

Unit: kPa

5.1.3 Cycle status/ Error cord display

Indicate sterilization status, referring to the “window of sterilization cycle”.

When the sterilizer alarms, a corresponding error code will be displayed. Check the malfunction parts according to the error code list (please contact the local dealer or our service dept).



5.2 Controlling Button

5.2.1 “UNPACKED”

Used for unwrapped instruments at 134°C, 210kPa, 1 time vacuum.

5.2.2 “PACKED”

Used for packed instruments, handpieces etc. at 134°C, 210kPa, 3 time vacuum.

5.2.3 “PRION”

Used for prion, bacteria and virus etc. at 134°C, 210Kpa, 3 time vacuum.

5.2.4 “POROUS”

Used for cotton yarn and similar articles at 121°C,110Kpa, 3 time vacuum.

5.2.5 TEST

Choose Vacuum Test or BD Test.

5.2.6 START

Start the program that has been selected. Holding it for 3-second during a running cycle, the cycle will be terminated.

5.2.7 “IN” indicator

Low water indicator, it will illuminate when the distilled water level is too low, to warn you that water should be added in (distilled water is still enough for this running cycle). (6.2)

5.2.8 “OUT” indicator

Full water indicator, it will illuminate when the waste water tank is full, to warn you that water should be drained out. (6.3)

5.2.9 CUSTOM PROGRAM

Press all the programs, and then all program indicators will illuminate. Holding PROG. button to enter bluetooth print interface, and press it again, to enter custom program as below:

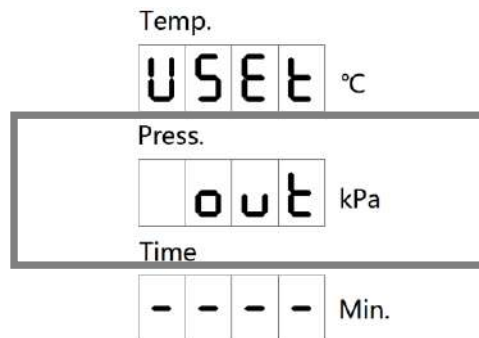

There are five statuses in the second line:

- tE (sterilization temperature);
- St (sterilization time, adjustable 20~60mins for 121°C, 4~20mins for 134°C);
- dr (drying time, adjustable 0~60mins);
- UA (vacuum times, 1 time & 3 times & 5 times can be chose);
- out (quit);

Press TEST button to switch statuses;

Press PROG. button to add count & confirm;

Press START button to minus count.

5.3 Sterilization Program

When sterilizer power switched on, you can select following programs by different items:

Program	Temp.	Pres.	Vacuum Times	Sterilization Time	Drying Time
UNPACKED	134°C	210kPa	1	4 min	9 min
PACKED	134°C	210kPa	3	5 min	9 min
PRION	134°C	210kPa	3	18 min	9 min
POROUS	121°C	110kPa	3	20 min	18 min

5.4 Window of Sterilization Cycle

3 times pre-vacuum program example: PACKED 134°C

<div style="border: 1px solid black; padding: 5px; text-align: center;"> 21.3 0.7 HE </div> <p style="text-align: center;">Preheating</p>	<div style="border: 1px solid black; padding: 5px; text-align: center;"> 21.3 -80.4 UA.1 </div> <p style="text-align: center;">1st vacuum</p>	<div style="border: 1px solid black; padding: 5px; text-align: center;"> 116.7 80.8 Pr.1 </div> <p style="text-align: center;">1st pressurize</p>
<div style="border: 1px solid black; padding: 5px; text-align: center;"> 21.3 -80.4 UA.2 </div> <p style="text-align: center;">2nd vacuum</p>	<div style="border: 1px solid black; padding: 5px; text-align: center;"> 116.7 80.8 Pr.2 </div> <p style="text-align: center;">2nd pressurize</p>	<div style="border: 1px solid black; padding: 5px; text-align: center;"> 21.3 -80.4 UA.3 </div> <p style="text-align: center;">3rd vacuum</p>
<div style="border: 1px solid black; padding: 5px; text-align: center;"> 116.7 80.8 Pr.3 </div> <p style="text-align: center;">3rd pressurize</p>	<div style="border: 1px solid black; padding: 5px; text-align: center;"> 134.8 218.3 St </div> <p style="text-align: center;">Sterilization</p>	<div style="border: 1px solid black; padding: 5px; text-align: center;"> 21.3 0.7 rE </div> <p style="text-align: center;">Exhaust</p>
<div style="border: 1px solid black; padding: 5px; text-align: center;"> 21.3 -80.4 dr </div> <p style="text-align: center;">Dry</p>	<div style="border: 1px solid black; padding: 5px; text-align: center;"> 90.2 0.11 PASS </div> <p style="text-align: center;">End</p>	

1 time pre-vacuum program example: UNPACKED 134°C

<div style="border: 1px solid black; padding: 5px; text-align: center;"> 21.3 0.7 HE </div> <p style="text-align: center;">Preheating</p>	<div style="border: 1px solid black; padding: 5px; text-align: center;"> 21.3 -80.4 UA.1 </div> <p style="text-align: center;">1st vacuum</p>	<div style="border: 1px solid black; padding: 5px; text-align: center;"> 116.7 80.8 Pr.1 </div> <p style="text-align: center;">1st pressurize</p>
<div style="border: 1px solid black; padding: 5px; text-align: center;"> 134.8 218.3 St </div> <p style="text-align: center;">Sterilization</p>	<div style="border: 1px solid black; padding: 5px; text-align: center;"> 21.3 0.7 rE </div> <p style="text-align: center;">Exhaust</p>	<div style="border: 1px solid black; padding: 5px; text-align: center;"> 21.3 -80.4 dr </div> <p style="text-align: center;">Dry</p>
<div style="border: 1px solid black; padding: 5px; text-align: center;"> 90.2 0.11 PASS </div> <p style="text-align: center;">End</p>		

Chapter 6 Operation Process

6.1 Switching On

Please connect the power line before you start the operation.

Open door before turning on the sterilizer, showing flickering "LD" on the state display window. If it indicates "Do", even you push start button it will not work. (pic 6-1)

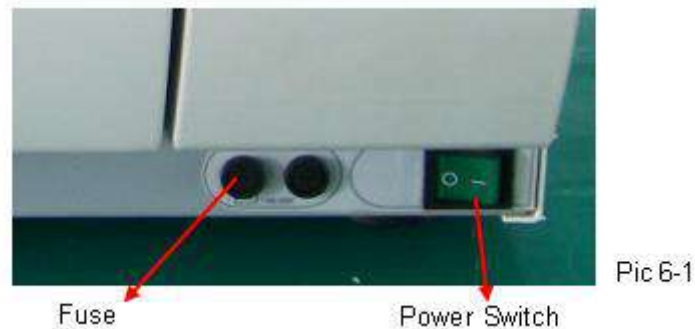

ATTENTION: If you did not operate the panel more than 40secs, the screen will be off automatically for saving power. It will resume when you press any button.

6.2 Distilled Water Adding

Switching on sterilizer, if the "IN" indicator illuminated, it means the distilled water in the water tank is of its lowest level and you have to add water in. And even press "START" button, it will not work either, so you need to add distilled water until the indicator light off.

Fill in distilled water from the top of sterilizer. (pic 6-2)



CAUTION: Use distilled water only to extend the life time of sterilizer.

Do not tilt the sterilizer when the reservoir is full of water.

6.3 Alarming if Used Water Reservoir is Full

The “OUT” indicator light illuminates during the cycle, which means that the used water tank needs to be drained.

Connect the drainage tube to used water outlet, and used water will be drained automatically.



Generally, the maximum temperature of drained water should be under 70°C. If it is higher, you need to check whether the fan work normally, or contact the local distributor immediately.

6.4 Selecting Sterilizing Program

Select the required sterilization program which you need. When you choose, the corresponding indicator light will be illuminated.

6.5 Loading Articles

Articles should be put on the trays with some gap between each articles so that the steam can be ventilated freely. Please use the attached removal tool to load trays into chamber to avoid scalding. (pic 6-4)



Tray arrangement note:

- ❖ Read the following instructions for proper placing of articles and material.
- ❖ Make sure that the articles of different materials are separated and placed on different trays.

- ❖ In case of carbon steel articles, place a towel or paper-wrap between the tray and the articles in order to avoid a direct contact.
- ❖ All the articles must be sterilized in an open position.
- ❖ Make sure that the articles remain apart during the sterilization cycle.
- ❖ Do not overload the trays.

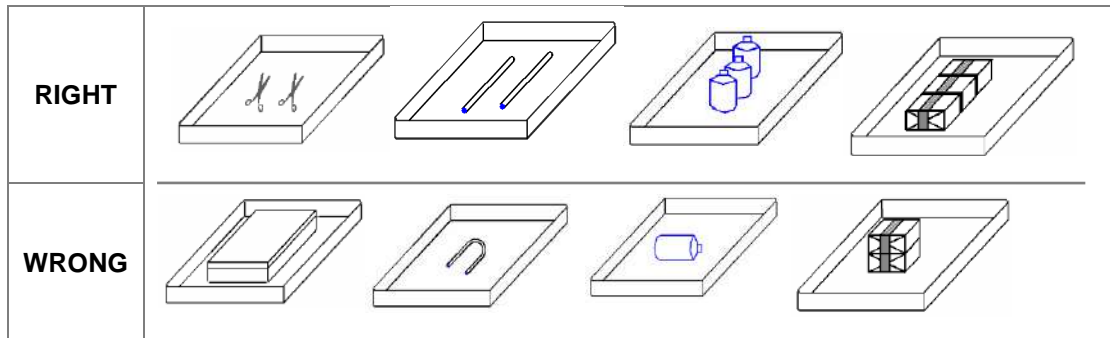

CAUTION: Recommended to clean the articles before loading.

ATTENTION: It is helpful to turn on power for warming 5 ~ 10mins before running cycles, if the environment temperature under 10°C.

6.6 Closing the Door

Close the door after loading the articles. "LD" will be showed and will not twinkle anymore once latching the door handle fully.

If the chamber is warm and steam still be left in it, you may feel a strong resistance when you close the door. Just have to push harder and latch the handle completely. Also may keep the door open to release the steam and close again. Or you can push the door in while you turn the door handle.

Anyway, latch the door handle completely. If you are sure the door has not been closed properly, adjust the door.



Drawing Explanation:



CAUTION: The door should be shut tightly before running program to avoid the danger.

ATTENTION: The “Load” code will twinkle if the door not closed. The sterilizer will not run unless the door has been closed completely.

If the door has been opened during the cycle, the sterilizer will display error code”Er06”. Press “START” to cancel alarm, and then close the door to restart.

6.7 Starting a Program

Close the door completely, and press “Start/Stop” button to start a working cycle.

The sterilizer will heat, sterilize and drying articles automatically. The whole process will take 20-50mins. It depends on the articles being sterilized, the initial temperature, and the program you selected.

The Process of Sterilization

Pre-heating: Display HE

Chamber will start to be pre-heating when turning on the power switch, and keeping the chamber warm.

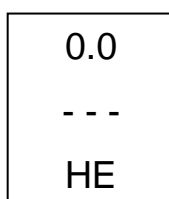

Pre-vacuum: Display -P

Outputted the airs in the chamber, and inputted steam in the chamber, run 3 cycle times.

-P

Po

Heating: Display HE

Keep heating until getting the time of sterilization.

0.5
106
HE

Sterilization: Display TIME

Display sterilizing time and temperature. The sterilizer keeps the temperature of sterilization with time is counted down.

1.1
121
20

2.1
134
4

Vacuum drying: Display PL OR TIME

Display dry-vacuum time and the temperature. Draining used water and steam. Sterilizer will automatically switch to vacuum drying process after the steam pressure drop and chamber temperature down.

0.2
95
PL

-P
86
2

End: Display ED

The buzzer make a sound means the total sterilization processes have been finished, then wait for the pressure down to “0” bar at the steam manometer on command front panel.

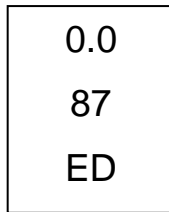

CAUTION: Releasing pressure until the pressure down to the 0 kPa or P.

Do not put or cover any stuff on the machine to keep heat venting well.

6.8 End of the Sterilization Working Cycle

When working cycle finished, the “ED” will illuminate and give you a sound of alerting. Then you can open the door and take the sterilized articles out.

WARNING: Do not try to open the door if the pressure does not show “0” kPa.

When the door opened, the sterilizer will return to the initial state, heat-preserving and waiting for next sterilizing cycle. Before starting a new cycle, it will be kept in a heat-preserving condition all the while.

CAUTION: After sterilizing has been finished, please use the removal tool to take the trays out from sterilizing chamber. It will be better to store sterilized articles after cooled down totally.

6.9 Power Off

If you finished the sterilization, please turn off the power switch. The power switch light will be off, and close the door but do not lock it.

If do not use it for a long time or for storage, please unplug the power cord.

ATTENTION: During the sterilizing, we suggest that you use the indicator tape. Put them in the chamber in order to ensure reliability of sterilization.

6.10 Abnormal Exiting

In the cycle, if the program is interrupted by the error or press "start/stop" button 2times continuously, it will enter "abnormal exiting program" and show "EE" on the state window as followed:

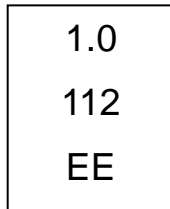

In this state the air release solenoid valve will be opened and exhaust air. You have to cancel this information by press "start/stop" button, and then to back normal state window.

WARNING: Do not try to open the door if the pressure does not show "0" kPa.

Chapter 7 Essential Information

Please ensure the sterilizer operated correctly. It is very important to follow below points and carry out the necessary maintenance procedures as specified.

7.1 Please Ensure the Following....

- ❖ You have read and follow these operating instructions.
- ❖ The load is suitable for sterilizing in the selected program.
- ❖ The load can be sterilized at the selected temperature.
- ❖ The load has been rinsed thoroughly in clean water before sterilization to avoid any chemical residues left after cleaning contaminating the sterilizer.
- ❖ When placing instruments on trays, ensure that they are placed on the ribs of the tray (to help drainage), they must not touch each other and must not interfere with other trays or the chamber above.
- ❖ Only distilled water can be used.
- ❖ The sterilizer should be set in a ventilated area.
- ❖ The sterilizer is not installed in an enclosed cupboard space.
- ❖ Keep the door ajar if not in use.
- ❖ Only qualified personnel could do the service of sterilizer.
- ❖ Keep and reserve the package for transportation.
- ❖ If the place which you use the machine is over 500m height, it should be set before use. You can contact with local dealer for the detail.

7.2 And Please Do Not....

- ❖ ...lose this manual.
- ❖ ...add any chemicals or whatsoever analogous water to the sterilizer.
- ❖ ...attempt to sterilize volatile substances, toxic materials or other unsuitable loads. Refer to your "Authorized Person" for advice.
- ❖ ...place the sterilizer in direct sunlight.

- ❖ ...place the sterilizer on heat sensitive surfaces.
- ❖ ...use inappropriate cleaning materials.
- ❖ ...drop or abuse the sterilizer.
- ❖ ...use in areas of risk associated with flammable materials or gases.

Chapter 8 Maintenance

8.1 Maintenance Schedule Chart

Maintenance Required	Person Responsible
Daily	
Clean Door Gasket	User
Clean Chamber	User
Weekly	
Clean Chamber, Trays and Rack	User
Clean Water Draining Filter	User
Monthly	
Clean Reservoir	User
Yearly	
Performance verification and maintenance	Qualified service personnel
As Required	
Change Door Gasket	User
Cleaning function	User

8.2 Daily Maintenance

Cleaning Door Gasket

The door gasket and the mating surface should be wiped off clean each day with a clean, damp cloth. Do not use abrasive cleaners on the gasket or mating surface.

Use warm soapy water for keeping marks of sterilizer persistent, but ensure any soap residues are completely removed by wiping both the gasket and the vessel again with water using a lint free damp cloth.

WARNING: Refer to qualified personnel for servicing.

Never use a wire brush, steel wool, abrasive material, or chloride-containing products to clean door and chamber assembly.

“Caution hot surface. Avoid contact.” ensure that the sterilizer is cooled down fully before cleaning to avoid burns.

Cleaning after Liquid Loads

Biological media tends to boil at a higher rate than other liquids during venting. This causes media to be spattered inside the chamber. Therefore, the chamber must be cleaned daily when you are sterilizing media. Cleaning as follows:

- ❖ Allow unit to be cooled down.
- ❖ Wipe out chamber and door with a clean, damp cloth.

WARNING: Failure to keep the interior of the stainless steel chamber free of mineral deposits and debris can cause premature failure of the sterilizer.

8.3 Weekly Maintenance (More Often If Necessary)

Cleaning Chamber, Trays and Rack

At least once a week, the trays and tray rack should be removed from the sterilizer chamber. The trays, tray rack and chamber should be thoroughly cleaned to remove any deposits from the surfaces.

Clean the trays, rack and chamber (especially the bottom of the chamber) with appropriate anti biological cleaners. Wipe all residues from the surfaces with a dampened, lint-free cloth.

WARNING: To prevent from collection of mineral deposits and corrosion of chamber components, use distilled water only as specified. Clean chamber after each use if sterilizing saline solutions.

Cleaning water draining filter

Water draining filter (pic 8-1) might has been jammed by some dust because of use for a long-term, so effect of vacuum and drying would be influenced. Some tiny impurity might be deposited on the filter after a long-term use, blocking the filter, so as to influence the effect of

the vacuuming and water discharging. The kinds of impurity come from smeary dust on the instruments being sterilized or some calcification in the water.



Keep cleaning of the inside chamber in order to make life-time of filter much longer. Please take the following advice for consideration:

- ❖ Use eligible distilled water.
- ❖ The articles should be cleaned before placing in. It is good to use specified packing for the articles with oil or other impurity, don't forget to seal up.
- ❖ Rotate the filter which composed by filter net tube (A) and filter holder (B) inside the chamber.



Cleaning both parts, ensure that there is no any dirty thing on it (suggest to clean by ultrasonic cleaning machine). Then set it back to the bottom of the chamber.

8.4 Monthly Maintenance

Cleaning Reservoir

There are some impurities and some toxins had been left behind in the reservoir because distilled water stored for a long time. Need to drain and clean regularly. As pic 8-3 shows, loose the screw by screw-driver, and open the cover to clean inside.



pic 8-3

ATTENTION: Make sure that use distilled water properly in order to extend the sterilizer life-time.

Do not rave about the sterilizer when the tank has been filled.

8.5 Other Maintenance

Changing Door Gasket

Tool: A plain screw driver without sharp head is needed.

Cut off the power supply, ensure that the sterilizer is cool and depressurized.

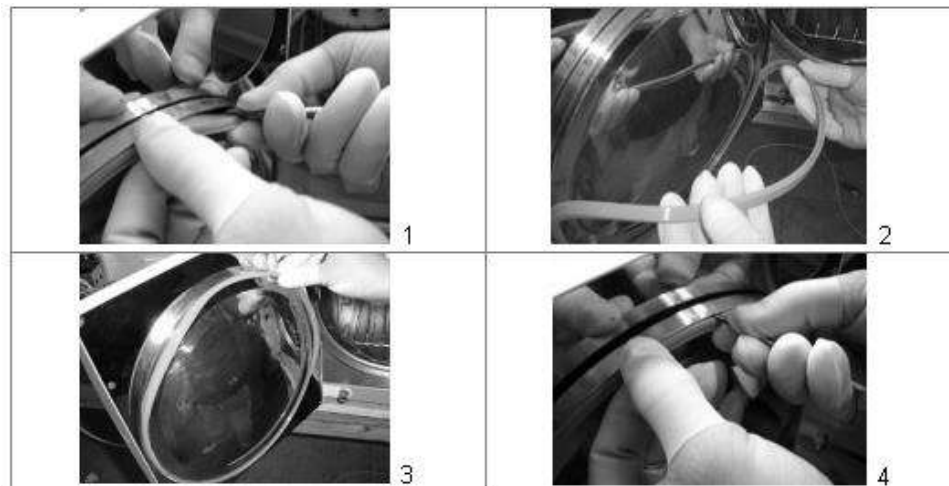

1. Hold verge of the seal by one hand softly, and another hand should be inserted the screwdriver into the gap between gasket and door, take out the seal slowly.
2. Once you take out one part of the seal, you can draw out the whole seal slowly. After taking out the seal, please check and clean the groove of gasket, so does the gasket, please replace it if there is some damage.
3. Fix the clean gasket in initial door groove. At first, embed 4 spots equably into groove when fix the gasket, then embed the other parts. Next, embed it equably by hands.
4. The inner edge of gasket may be ectropion during embedding it in the door groove. You'd better to tight it back to the groove by using screwdriver carefully.

8.6 Servicing by the Approved Technician

Service is essential for consistently effective sterilization.

We recommend servicing by an approved technician every 2 years.

Check-list:

- 1 Checking the solenoid valves.
- 2 Checking the water pump.
- 3 Checking the vacuum pump.
- 4 Checking the distilled water drain valve and the used water drain valve.
- 5 Checking the relief valve.
- 6 Checking the door locking system.
- 7 Checking the probe of the pressure and temperature.
- 8 Checking the probe of the water in the sterilization chamber.
- 9 Checking the electrical connections.
- 10 Checking the hydraulic connections.
- 11 Checking the safety thermostat.
- 12 Cleaning the sterilization chamber.
- 13 Cleaning the trays and the tray rack.
- 14 Cleaning the reservoirs.
- 15 Replacing the water filter.
- 16 Replacing the air filter.
- 17 Replacing the door gasket.

Chapter 9 Transportation and Storage

9.1 Preparation before Transportation and Storage

Shut off the power switch, unplug the cord, and make the sterilizer been cooled down completely.

9.2 Draining

Drain water from reservoir and the condensate collector completely: insert the joint end of the attached tube to drain connection. The spout on the left is the water spout used for the “used-water out”, the one on the right is used for the “clean-water” drain spout.



9.3 Conditions for Transportation and Storage

- ❖ Temperature: -5 °C ~ +55°C
- ❖ Relative Humidity: ≤85%
- ❖ Atmospheric Pressure: 500HPa~1060HPa

9.4 Package

Package is used in transportation for protecting product, conveniently delivery and sales.

The sterilizer package requirement should as followed:

1. Product can not over 3/4 volume of package.
2. Product should be fix inside the package.
3. Package bag should be higher than product 6mm.

Appendix 1 Instruments Preparation Procedure

The articles should be treated as following:

1. Clean articles completely before sterilization, keep dry.
2. Pack articles into sterilization roll (if need).
3. Place articles onto trays.
4. Run selected sterilization programs.
5. Take out and store.

CAUTION: Make sure the packing of articles in good condition.

The sterilized articles still exist lots of warmth. Do not fold in order to exhaust the residual steam.

Appendix 2 Error Code List

The sterilizer will show Error information when malfunctions happen.

Example

1.0
112
Er01

Error Code List

No.	Error Code	Description
1	Er01	Steam generator over temperature
2	Er02	Heating ring over temperature
3	Er03	Chamber over temperature
4	Er04	Fail to maintain temperature and pressure
5	Er05	Pressure cannot be exhausted
6	Er06	Door is open during cycle
7	Er07	Working overtime
8	Er08	Over pressure
9	Er09	In-chamber sensors temp. too high or too low (for dual sensors only)
10	Er10	Temp. and pressure doesn't match
12	Er12	Vacuum fail
13	Er14	In-chamber sensors temp. differs too much (for dual sensors only)
14	Er27	Air pressure low (due to high altitude)
15	Er71	Pressure sensor output low
16	Er72	Pressure sensor output high
17	Er98	Out of power during cycle
18	Er99	Forced exit program

Appendix 3 Piping and Circuit Diagram

Piping Diagram

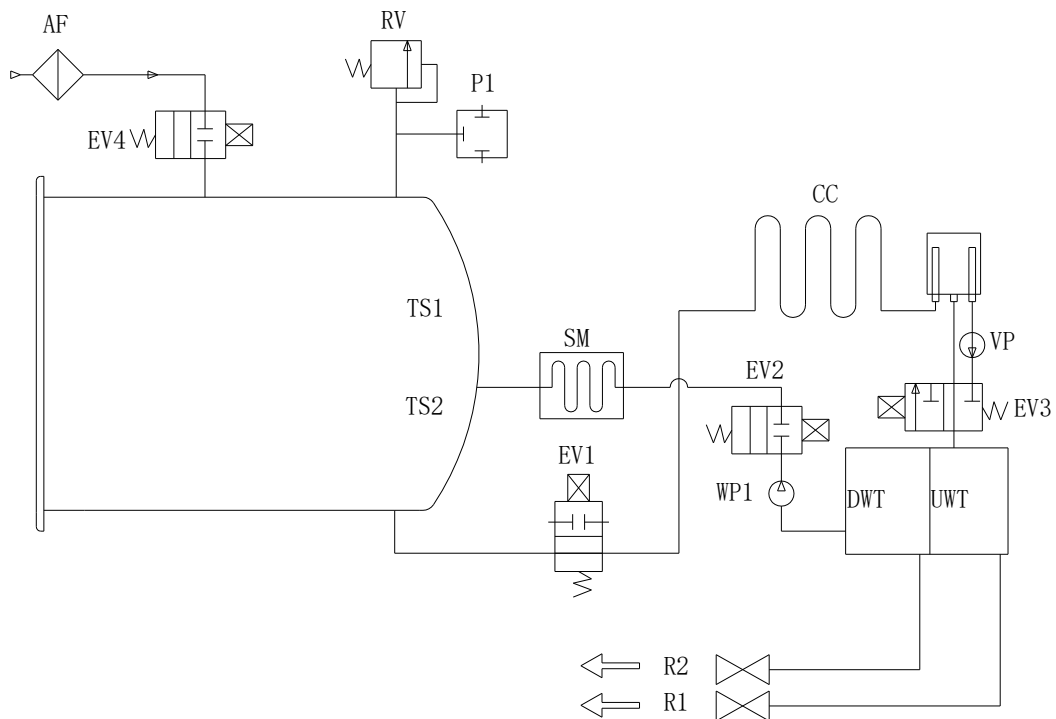

AF	Air Filter
UMT	The Used Water Tank
DWT	The Distilled Water Tank
EV1	Air Release Valve
EV2	Water Supply Valve
EV3	Vacuum Valve
EV4	Air Return Valve
P1	Pressure Sensor

SM	Steam Maker
WP1	Main Water Pump
VP	Vacuum Pump
CC	Condensate Collector
RV	Relief Valve
R1	Distilled Water Drain Valve
R2	Used Water Drain Valve
Ts1	Temperature Sensor

Circuit Diagram

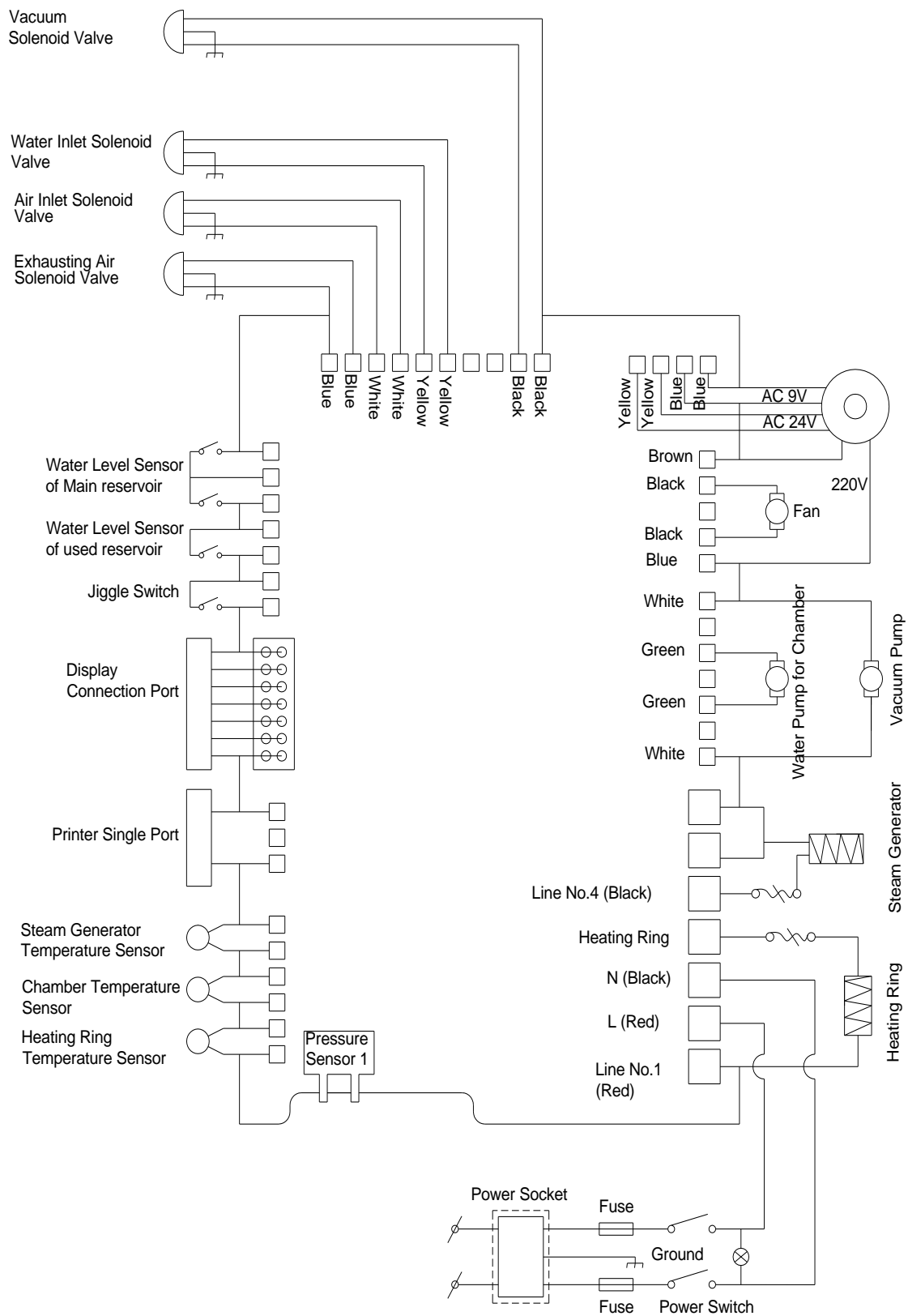

Appendix 4 The Standards of Testing

NO.	Testing item	Request of standards
1	Exterior	The exterior of sterilizer should be tidy and mustn't have disfigurements, e.g.deflection, hollowness, collision, nick, sharp edge.
2	Cover plate	The cover plate should be assured to disassemble easily in order to repair the equipment.
3	Digit and letter	The digit and letter in screen should be legible.
4	Electroplate Component	The electroplate should accord with YY0076-1992 class 2, which for the request of aspect.
5	Printer Component	The printer components should accord with YY1055-1999 the class II which for the request of aspect.
6	Door Safe Lock	On the normal condition, if the sterilizer door hasn't been locked tightly, the program can not start.
7	Chamber Pressure	The sterilizer should ensure that the door can't be opened when chamber pressure is greater than 0.27kPa.
8	Safety Valve	The sterilizer must install a safety valve, safety valve opening pressure $0.27\text{kPa} \pm 0.01\text{kPa}$, and automatically open when reaching the set value.
9	Sterilizing Program	Sterilizer should have the pre-established program about 121°C and 134°C , dressing and instruments.
10	Controlling System	The control system in sterilizer should limit the steam which in the chamber be controlled at the highest average temperature in $\pm 3^{\circ}\text{C}$ of pre-establish station. And ensure the temperature value accords with the pressure controlling value.
11	Timing Control	Able to timing control of the sterilization and drying, and the error should not be greater than 10% of the preset value.
12	Button and Switch	Buttons and switches should be flexible and reliable on the sterilizer.
13	Indicator and Display	The indicators and displays of sterilizer should show the states of every sterilizing procedure exactly. Under the normal situation, sterilizer should indicate: <ul style="list-style-type: none"> a) Chamber temperature b) Chamber pressure c) Sterilizer working state d) Water level state e) State of door
14	Quantum of Leakage	In the condition of the vacuum - 0.07Mpa, the sterilizer shouldn't leak 0.13kPa/min.
15	Leakage Forbidden	The sterilizer can't leak under the work pressure

16	Protective Earthing Impedance	The impedance between protective earthing point of the power input faucet and protective earthing can be touched all metallic parts, doesn't over than 0.1Ω.
17	Successional Current Leakage under Work Temperature	a) Earth leakage current on the normal condition: ≤0.5mA, the single blooey state: ≤1 mA
		b) Crust leakage current on the normal condition: ≤0.1 mA, the single blooey state: ≤0.5mA
18	Dielectric strength with Working Temperature	a) A-a1: It should bear the sine wave test alternative voltage, 50Hz, 1500v, which between the web power input port and protective earthing can be touched all metallic parts. It lasts 1min, and hasn't the phenomenon of breakage and flashover.
		b) A-a2:It should bear the sine wave test alternative voltage, 50Hz, 1500v, which between the web power input port and the enclosure of which isn't be pretended earthing. It lasts 1min, and hasn't the phenomenon of breakage and flashover.
19	Empty Load	For all loads except hollow load A, the presence of saturated steam in the usable space and the load is deemed to have been achieved when, throughout the holding time, all temperatures measured in the usable space and the load. Attention: the theory of steam temperature is accounted by measuring pressure, which can be considered the test temperature.
		are not lower than the sterilization temperature.
		are not more than 4 K above the sterilization temperature.
		do not differ from each other by more than 2 K.
		The usable place temperature during the no-load can not over than the scope of highest temperature.
20	Hollow Load	For hollow load A and B, in order to confirm the presence or absence of saturated steam, discriminate whether the indication system change in accordance with the system manufacturer predetermined color.
21	Dryness, Solid and Wrapped Load	For wrapped load, any remaining moisture should not lead to wet packages and shall not result in detrimental effects on the sterilizer load. Any remaining water droplets on the inner side of pouch should evaporate within 5 min.
		For solid load the moisture content should not exceed 0.2%.